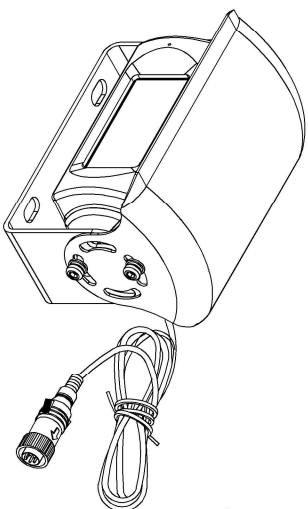
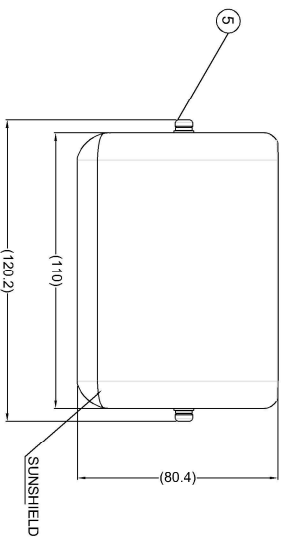
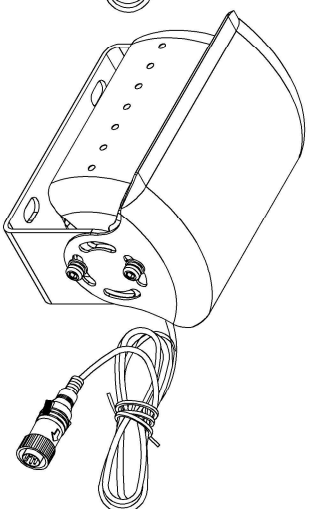

TABLE 1: BE-81XC CAMERA ONLY OPTIONS

PART NO.	MODEL NO.	DESCRIPTION
1242E	BE-810C	CAMERA ELITE, HEATED, SHUTTER, ULTRA-LOW-LIGHT, AUDIO (PAL)
2914D	BE-811C	ELITE CAMERA, HEATED SHUTTER & AUDIO (NTSC)



SHUTTER UP



SHUTTER DOWN

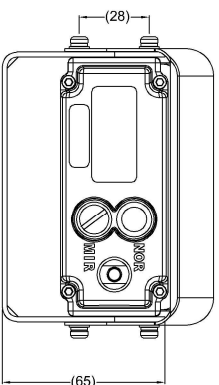
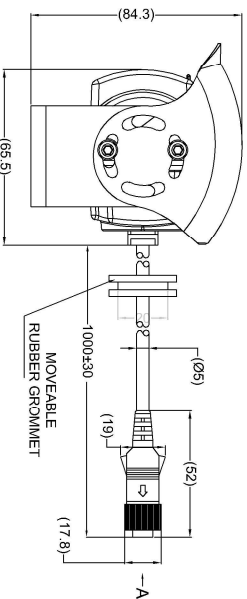
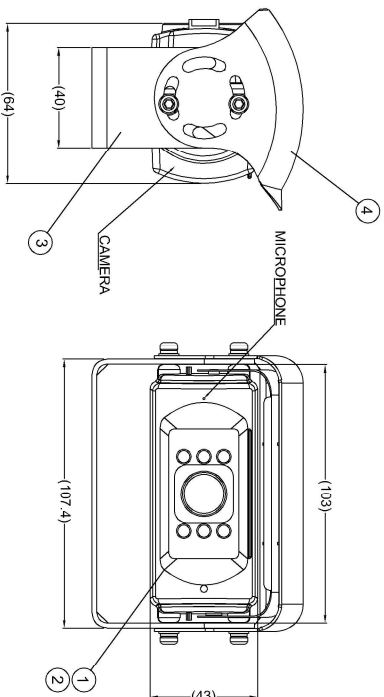

VIEW A

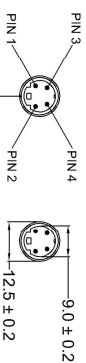
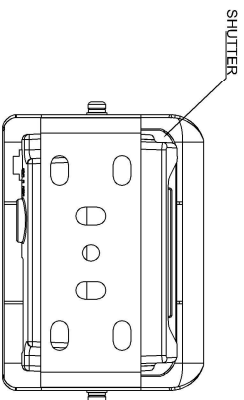

4 PIN MINI DIN MALE MATING FACE

PIN #	WIRE COLOR	DESCRIPTION
1	YELLOW	VIDEO
2	RED	VIDEO
3	BLUE	ASD CONTROL
4	WHITE	SHUTTER (CONTROL) AUDIO
5	SHIELD	GND

TABLE 2: CAMERA KIT CONTENTS

ITEM	①	②	③	④	⑤	⑥
PART NO.	3417E	3526D	3417E	3418A	3246	3419D
MODEL NO.	BE-810C-C	BE-811C-C	BE-81XX & BE-21XC BKT	BE-81XC & BE-21XC SS	BE-81XX & BE-21XC FXK	BE-81XCIG
DESCRIPTION	CAMERA ELITE, HEATED, SHUTTER, ULTRA-LOW-LIGHT, AUDIO (PAL)	CAMERA ELITE, HEATED, SHUTTER & AUDIO (NTSC)	BE-21XC-BKT MOUNTING BRACKET	BE-81XC & BE-21XC SS SUNSHIELD	BE-81XC & BE-21XC FXK FIXING KIT	BE-81XC INSTALLATION GUIDE (NOT SHOWN)
BE-810C QTY.	1	-	1	1	1	1
BE-811C QTY.	-	1	-	1	1	1

NOTES:

- REFER TO PRODUCT SPECIFICATION FOR PRODUCT SPECIFICATIONS.
- FOR PRODUCT LABEL AND PACKAGING INFORMATION REFER TO MASTER BOM.
- ANY CUSTOMERMODIFICATION OF THISPRODUCT CAUSING SUBSEQUENT FAILURE IS NOT A LIABILITY OF BRIGADE ELECTRONICS PLC.

PROPRIETARY NOTICE

THIS DESIGN AND TECHNICAL INFORMATION APPEARING ON THIS DRAWING IS THE PROPERTY OF BRIGADE ELECTRONICS, AND IS DISCLOSED IN CONFIDENCE. IT IS NOT TO BE COPIED, REPRODUCED, REVEALED TO OR EXPLOITED BY OTHERS, EITHER IN WHOLE OR IN PART WITHOUT THE EXPRESS WRITTEN CONSENT OF BRIGADE ELECTRONICS.

Revision Notes:

RT -	Drawn:	Checked:	Approved:	Date:
APA:				

BRIGADE
www.brigade-electronics.com

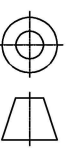

Third Angle

Assembly Pl Approval	Approved by	Checked by	Drawn by
TCHOI	SLAVER	JTYRRELL	S GOVENDER

Status RELEASED	Part No	Scale	Released	Assembly Ref
	BE-004435-00-20	N/A	17/09/20	

BE-81XC